

Body-Solid

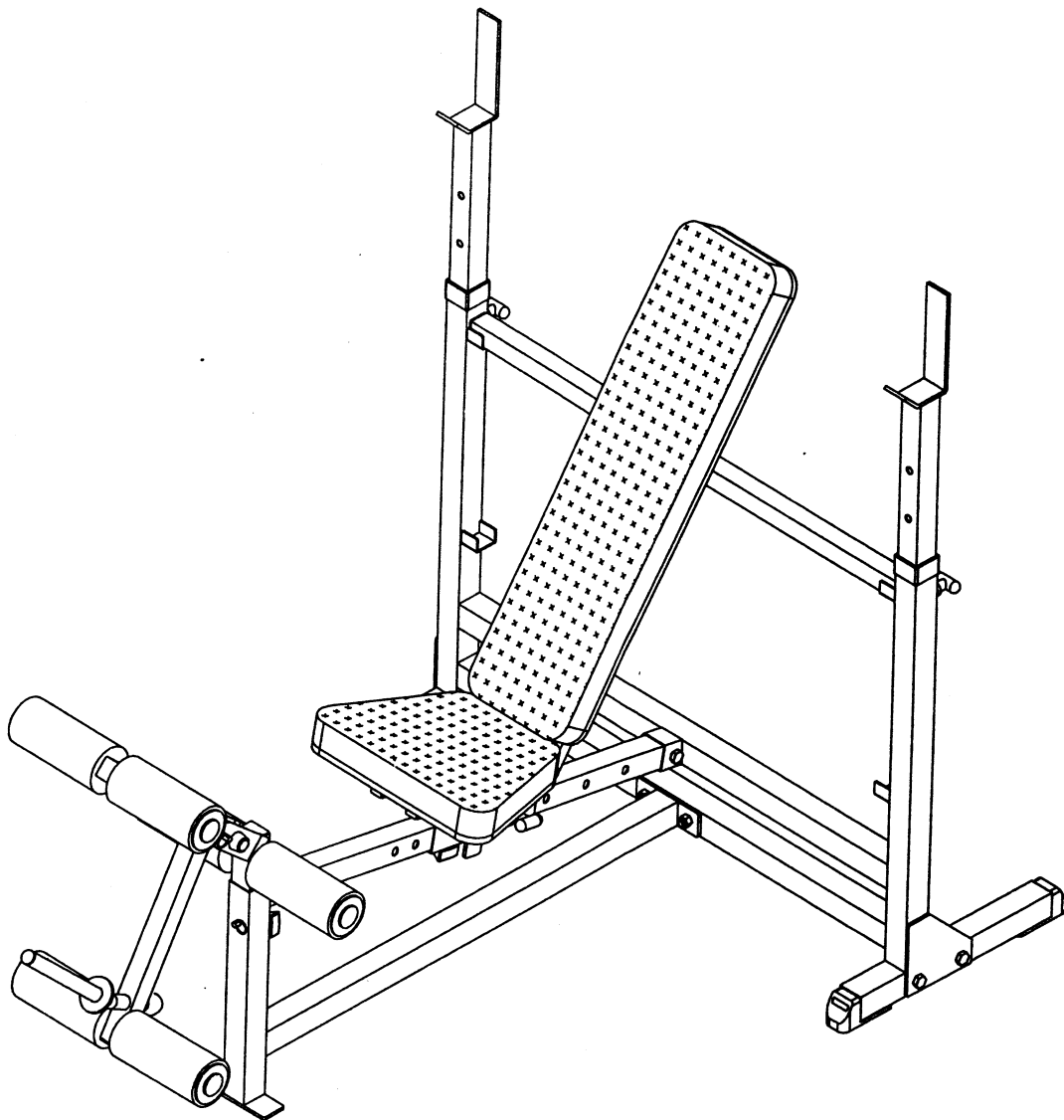

BODY-SOLID, Inc.
1900 S. Des Plaines Ave.
Forest Park, IL 60130 USA
Phone: (708) 427-3555
Fax: (708) 427-3556
www.bodysolid.com

GDIB46L OWNER'S MANUAL

GDIB46L ASSEMBLY INSTRUCTIONS

TABLE OF CONTENTS

General Instructions	2
Training Tips and Safety Information	3
Inspection and Maintenance Schedule	4
Hardware Illustration	5
Parts Illustration	6
Assembly (Step 1)	7-8
Assembly (Step 2)	9-10
Assembly (Step 3)	11-12



GDIB46L ASSEMBLY INSTRUCTIONS

GENERAL INSTRUCTIONS

Thank you for purchasing the Body-Solid equipment. At Body-solid, our goal is to ensure customer satisfaction. If you have any questions about these instructions or have any problems with assembly or parts for this machine, please call our Customer Service Department at 1-800-556-3113.

Prior to assembling any Body-Solid machine, please take the time to read the instructions thoroughly. Please use this manual to make sure that all parts have been included with your shipment. When ordering replacement parts, please refer to the part number and description of each part from this manual. Use only Body-Solid replacement parts when servicing any Body-Solid machine. Failure to do so may void your warranty and could result in personal injury.

Body-Solid equipment is designed to provide the safest, smoothest and most effective workouts possible. After you have finished assembling this product, check all stations to ensure correct operation. If for some reason you experience problems with any functions of this machine, do not continue operation. First, re-check all of the assembly instructions to locate any possible errors made during assembly. If you are not able to correct the problem, contact our Customer Service Department immediately at 1-800-556-3113.

TOOLS REQUIRED

- Socket Wrench
- 5/16", 3/8" and 1/2" Sockets
- Crescent Wrench
- Rubber Mallet

GDIB46L ASSEMBLY INSTRUCTIONS

TRAINING TIPS AND SAFETY INFORMATION

Before starting any exercise program, it is recommended that you consult your physician and get a complete physical examination. There is a risk assumed by individuals who use this type of equipment. To minimize risk, follow the rules below.

- Always consult your physician before starting any exercise program.
- Do not allow children or minors to play on or around the equipment.
- Warm up properly before engaging in any weight training regimen.
- Before using, read all the warning labels and instructions on the use of this machine.
- Do not modify the machine in any way.
- Inspect the machine before use for any damaged, worn or missing parts. If there is any doubt about the ability of this equipment to operate safely, do not use the equipment until it is serviced.
- Exercise with care, performing exercises at a smooth, moderate pace. Never perform jerky or uncoordinated movements that may result in injury.
- Never hold your breath while exercising.
- Learn how to perform the exercise correctly before using heavy weight. Correct form is important to avoid injury and to ensure that you work the proper muscle groups.
- It is recommended that you train with a training partner.
- Keep body and clothing clear of cables and moving parts when the machine is in use.
- Know your limitations. If you are new to resistance training or are starting an exercise routine after a prolonged lay-off, start slowly and build up to a more intense routine.

Failure to follow these rules may result in serious injury. If unsure about the proper use of the machine, consult your local Body-Solid distributor or call the Body-Solid Customer Service department at 1-800-556-3113.

GDIB46L ASSEMBLY INSTRUCTIONS

INSPECTIONS AND MAINTENANCE SCHEDULE























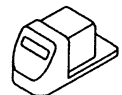

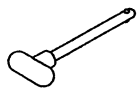
There is a risk assumed by individuals who use this type of equipment. To minimize risk, follow the rules below.

- Inspect equipment daily, ensuring that all nuts, bolts and screws are fully tightened.
- Inspect cables daily ensuring they are routed properly and not worn, frayed or stretched. Check and adjust tension on cables daily.
- When using pop-pin adjustments, always make sure the plunger for the pop-pin is securely inserted into an adjustment hole.
- Before performing any exercise, always make sure all ball-pins, ring-pins, pop-pins and selector pins are inserted properly and all snap-links are properly closed.
- Replace worn parts immediately.
- Human perspiration is corrosive. Clean your machine regularly. Wipe down and dry upholstery and frame pieces on a daily basis.
- Every week clean the chrome guide rods with a dry cloth and apply a coat of dry silicon spray or Teflon based spray lubricant.
- Every week clean and lubricate all non-chrome guide rods and all seat posts and adjustments for starting positions.
- Every week check hand grips, rollers and non-skid surfaces for wear.
- Only use Body-Solid parts. Parts from other manufacturers or any other modifications will void the warranty and may result in serious injury.
- Do not use this machine with damaged, worn or missing parts.
- If there is any doubt about the ability of this equipment to operate safely, do not use the equipment until it is serviced.
- Please ensure that all warning stickers are visible and acknowledged by users of the equipment.

Failure to follow these rules may result in serious injury. If unsure about the proper use of the machine, consult your local Body-Solid distributor or call the Body-Solid Customer Service department at 1-800-556-3113.

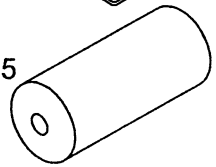
GDIB46L ASSEMBLY INSTRUCTIONS

HARDWARE ILLUSTRATION

		Qty.
A1		A1. M12X75 HEX HEAD BOLT ----- [6PCS]
A2		A2. M8X45 HEX HEAD BOLT ----- [10PCS]
A3		A3. 1/2"X85 HEX HEAD BOLT ----- [1PCS]
A4		A4. M12X70 HEX HEAD BOLT ----- [1PCS]
B1		B1. M12 NYLON LOCK NUT ----- [7PCS]
B2		B2. 1/2" NYLON LOCK NUT ----- [1PCS]
C1		C1. M12 (I.D) WASHER ----- [8PCS]
C2		C2. M8 (I.D) WASHER ----- [10PCS]
C3		C3. M8 SPRING WASHER ----- [10PCS]
C4		C4. M12 ROUND CAP WASHER ----- [2PCS]
D1		D1. 30X30 END CAP (9211-002) ----- [1PCS]
D2		D2. 1"X1" END CAP (9211-001) ----- [4PCS]
D3		D3. 38X38 RUBBER BAR CATCH (9310-001) ----- [2PCS]
D4		D4. 2"X2" FOOT CAP (9211-024) ----- [4PCS]
D5		D5. 60X45 NYLON BUSHING (9211-032) ----- [2PCS]
D6		D6. 50X45 NYLON BUSHING (9211-030) ----- [2PCS]
D8		D8. ϕ 10X120L BALL PIN (8250-017) ----- [1PCS]
D9		D9. ϕ 10X65L RING PIN (8250-015) ----- [1PCS]
D10		D10. 1 1/2"X1 1/2" END CAP (9211-003) ----- [5PCS]
D11		D11. 1/2" BOLT CAP ----- [2PCS]
D12		D12. 45X45 END CAP (9211-004) ----- [1PCS]
D13		D13. ϕ 1" ROUND END CAP (9211-016) ----- [1PCS]
D14		D14. ϕ 1" RUBBER CANE TIP (9212-019) ----- [1PCS]
D15		D15. ϕ 3 1/2"X8" FOAM ROLLER (9161-007) ----- [6PCS]
D16		D16. ϕ 10X75L RING PIN (8250-034) ----- [1PCS]
D18		D18. ϕ 1" ROUND END CAP (8341-033) ----- [6PCS]
D19		D19. ϕ 3" NYLON WASHER (9214-008) ----- [6PCS]

GDIB46L ASSEMBLY INSTRUCTIONS

PARTS ILLUSTRATION

A [1PCS]

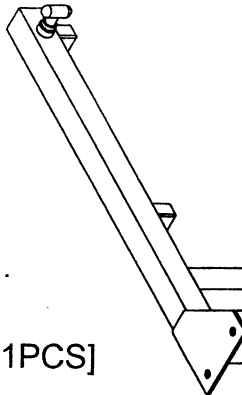

C [1PCS]

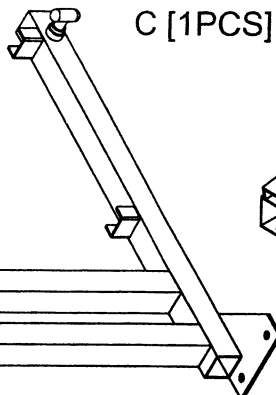

F [2PCS]

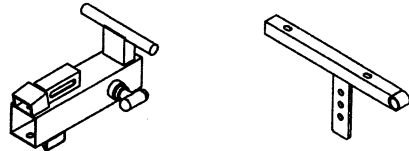

B [1PCS]

H [2PCS]

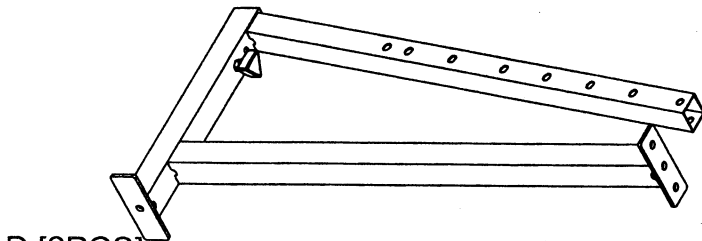
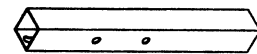

G [1PCS]

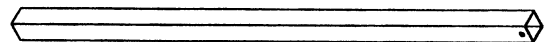

D [2PCS]

J [1PCS]

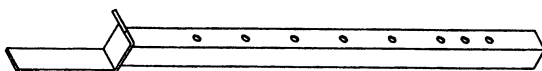

I [1PCS]

E [2PCS]

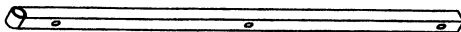
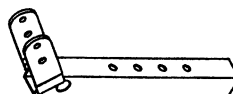

K [1PCS]

L [1PCS]

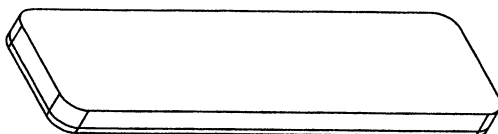
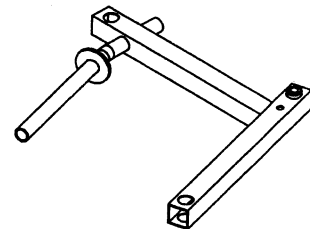

M [2PCS] ϕ 1"X1.6X483L

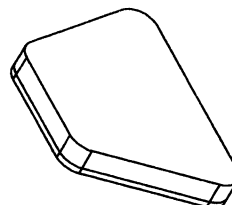

N [1PCS] ϕ 1"X1.6X493L

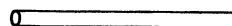
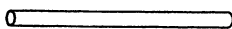

GDIB46L ASSEMBLY INSTRUCTIONS

ASSEMBLY- STEP 1

***Note : Do Not fully tighten frame bolts and nuts until after completing Step 1*

The following Parts and Hardware will be needed to complete Step 1

Parts Description			Hardware Description		
<u>Qty</u>	<u>Part</u>	<u>Part Description</u>	<u>Qty</u>	<u>Part</u>	<u>Part Description</u>
1	A	Back Cross Frame	6	A1	M12 x 75 hex head bolt
1	B	Middle Frame	1	A4	M12 x 70 hex head bolt
1	C	Seat Carriage	7	B1	M12 nylon lock nut
2	H	Bottom Support Frame	8	C1	M12 ID washer
			1	D1	30 x 30 end cap
			4	D4	2" x 2" foot cap
			2	D5	60 x 45 nylon bushing
			1	D9	10 x 65L ring pin

Step by Step

1. Attach 4 (D4) - Foot Caps to 2 (H) - Bottom Support Frame
2. Attach 2 (H) - Bottom Support Frame to (A) - Back Cross Frame, (note: make sure that longer length on 2 (H) - Bottom Support Frame is in the back of the bench)
3. Insert 2 - (D5) - nylon bushing into (C) - Seat Carriage
4. Slide (C) - Seat Carriage on (B) - Middle Frame, (note: T-shaped pivot bar and pop-pin housing must be toward the back as shown in diagram)
5. Attach (A) - Back Cross Frame to (B) - Middle Frame

****Securely Tighten All Frame Bolts Used in Steps 1**

GDIB46L ASSEMBLY INSTRUCTIONS

ASSEMBLY-STEP 1

THERE IS A RISK ASSUMED BY INDIVIDUALS WHO USE THIS TYPE OF EQUIPMENT. TO MINIMIZE RISK, YOU MUST FOLLOW THESE RULES:

1. Inspect equipment before each workout. Check that all nuts, bolts, screws and pop pins are in place and fully tightened. Also, before use, check cables for signs of wear. Replace all worn parts immediately. Never use machine if any parts are damaged or missing. Failure to follow these rules may result in serious injury.
2. Keep clear of the cables and all moving parts when the machine is in use.
3. Always make sure all Snap Links are closed when doing any cable/pulley exercises.
4. Exercise with care. Perform your exercises at a smooth moderate pace; never perform jerky or uncoordinated movements that may cause injury.
5. It is recommended that you should workout with a training partner.
6. Do not allow children or minors to play on or around this equipment.
7. If unsure of proper use of equipment, call your local Body-Solid distributor or the Body-Solid customer service department at 1-800-556-3113.
8. **WARNING:** Consult your physician before starting your exercise program. For your own safety, do not begin any exercise program without proper instruction.

RAL2-11-98

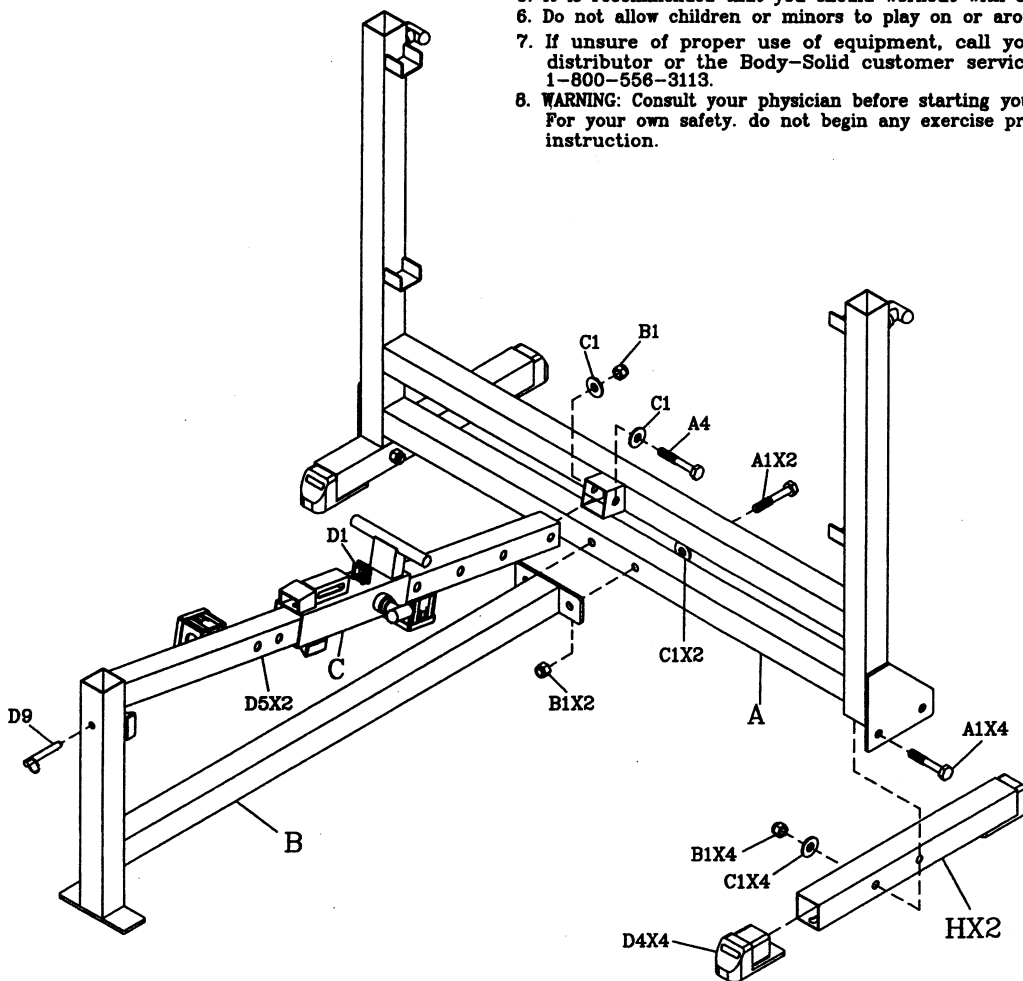

GDIB46L ASSEMBLY INSTRUCTIONS

ASSEMBLY- STEP 2

***Note : Do Not fully tighten frame bolts and nuts until after completing Step 2*

The following Parts and Hardware will be needed to complete Step 2

Parts Description			Hardware Description		
<u>Qty</u>	<u>Part</u>	<u>Part Description</u>	<u>Qty</u>	<u>Part</u>	<u>Part Description</u>
2	D	Lift Off	10	A2	M8 x 45 hex head bolt
2	E	Back Pad Frame	10	C2	M8 ID washer
2	F	Seat Pad Frame	10	C3	M8 spring washer
1	K	Back Pad	4	D2	1" x 1" end cap
1	L	Seat Pad	2	D3	38 x 38 rubber bar catch
1	G	Stablizing Bar	2	D6	50 x 45 nylon bushing
			1	D8	ϕ 10 x 120L ball pin
			2	D10	1 1/2" x 1 1/2" end cap

Step by Step

1. Attach 2 (F) - Seat Pad Frame to (C) - Seat Carriage, then attach (L) - Seat Pad to 2 (F) - Seat Pad Frame
2. Attach 2 (E) - Back Pad Frame to (C) - Seat Carriage, then attach (K) - Back Pad to 2 (E) - Back Pad Frame
3. Place 2 (D6) - nylon bushings into (A) - Back Cross Frame, then slide 2 (D) - Lift Off into (A) - Back Cross Frame
4. Attach 1 (G) - Stablizing Bar to (A) - Back Cross Frame

****Securely Tighten All Frame Bolts Used in Steps 2**

GDIB46L ASSEMBLY INSTRUCTIONS

ASSEMBLY-STEP 2

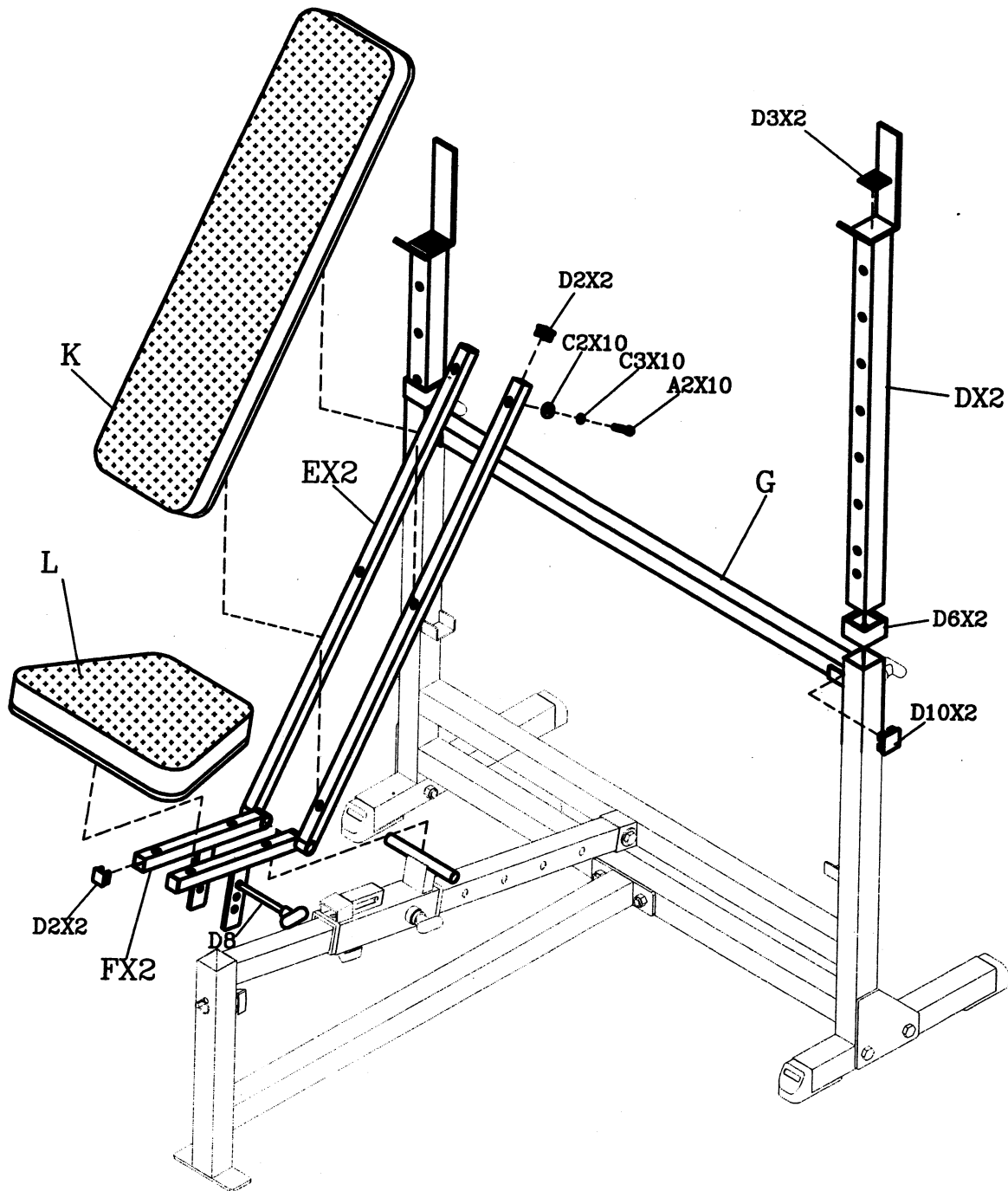

GDIB46L ASSEMBLY INSTRUCTIONS

ASSEMBLY- STEP 3

***Note : Do Not fully tighten frame bolts and nuts until after completing Step 3*

The following Parts and Hardware will be needed to complete Step 3

Parts Description

<u>Qty</u>	<u>Part</u>	<u>Part Description</u>
1	I	Leg Pivot Frame
1	J	Leg Frame
2	M	Short Frame Roller Bar
1	N	Long Frame Roller Bar

Hardware Description

<u>Qty</u>	<u>Part</u>	<u>Part Description</u>
1	A3	1/2" x 3 1/2" hex head bolt
1	B2	1/2" nylon lock nut
2	C4	1/2" round cap washer
1	D16	10 x 75L ring pin
3	D10	1 1/2" x 1 1/2" end cap
2	D11	1/2" bolt cap
1	D12	45 x 45 end cap
1	D13	1" round end cap
1	D14	1" rubber cane tip
6	D15	Foam rollers
6	D18	1" Round End Cap
6	D19	3" Nylon Washer

Step by Step

1. Attach (J) - Leg Frame to (I) - Leg Pivot Frame
2. Attach (N) - Long Foam Roller Bar to (I) - Leg Pivot Frame
3. Attach 2 (M) - Short Foam Roller Bar to (J) - Leg Frame
4. Place 6 (D15) - Foam Roller on (N) - Long Foam Roller Bar and 2 (M) - Short Foam Roller Bar

****Securely Tighten All Frame Bolts Used in Steps 3**

GDIB46L ASSEMBLY INSTRUCTIONS

ASSEMBLY-STEP 3

